



Miniature Fittings
and Luers

Eldon James

Featured Products:



Miniature Fittings - Barb sizes: 1/16" 3/32" 1/8" 5/32" 3/16" 1/4"
Thread Sizes: 10-32 10-32 Taper 1/4-28 and 1/16" NPT:
Pages 96-104

Custom Fittings Options - Select from a range of options and design configurations that are not stock items. Asymmetric Crosses & Tees, Threaded Crosses, Threaded Tees & Elbows, Reducers and Reduction Elbows: Pages 105-113



Male and Female Luers - Luers and Luer accessories made from USP Class VI materials and White Nylon.

White Nylon • Polypropylene • Radiation Stable Polycarbonate
Clear Polycarbonate • Bondable PVC: Pages 113-115

Soft Medical Tubing - Ultra-soft, made from a special non-allergenic, plastic medical alloy: Pages 126-127



Standard Flexelene™ Tubing - Flexible NSF 51 & 61 Certified polyethylene tubing: Pages 120-123

Colored Flexelene™ Tubing - Flexible NSF/ANSI 51 & 61 Certified polyethylene tubing: Pages 120-123

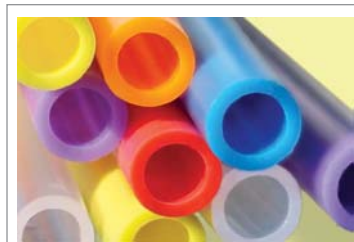

<http://eldonjames.com>

Eldon James Miniature Fittings Quick Reference Guide

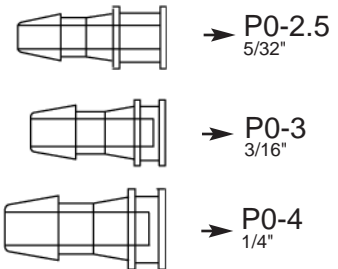
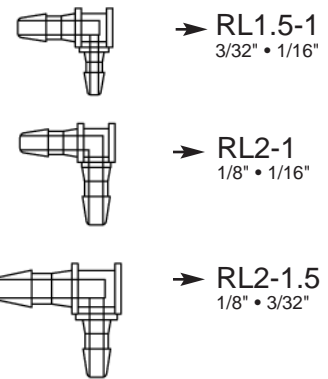
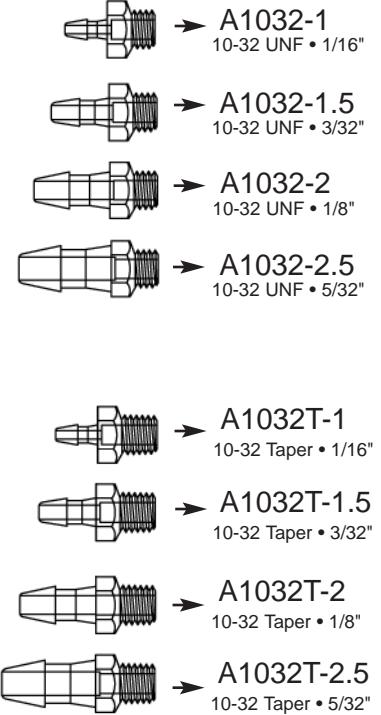
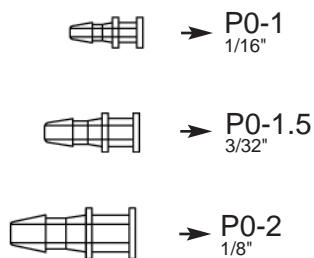
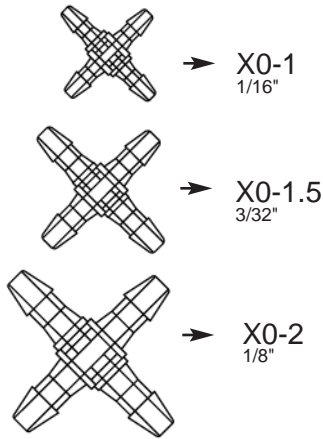
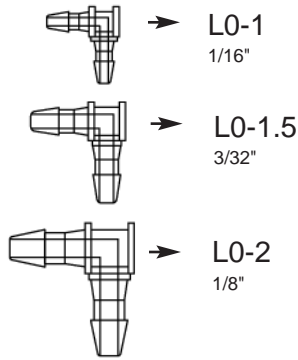
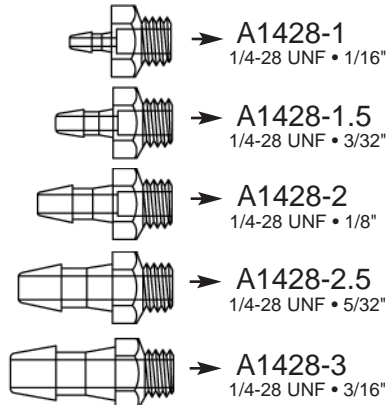
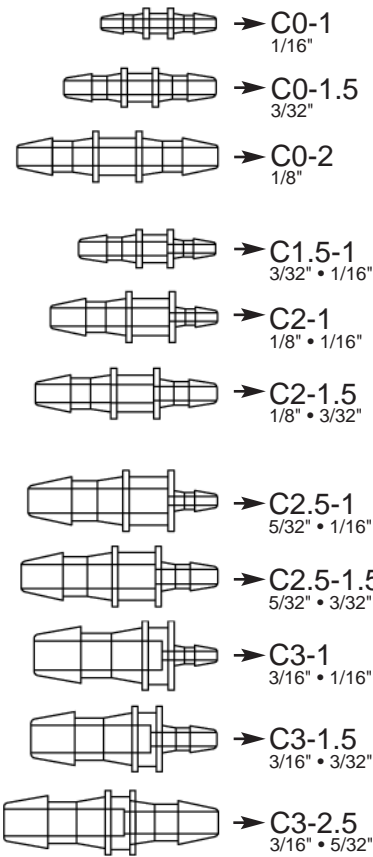
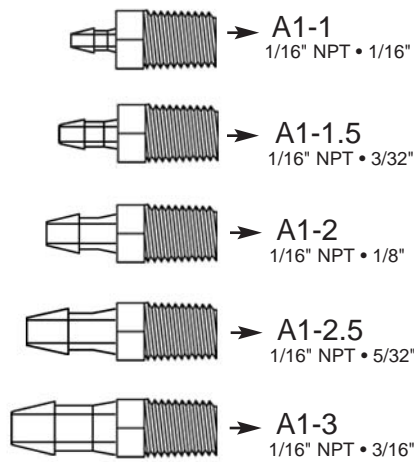

Additional In-between Reducer Sizes:

C2.5-2 5/32" x 1/8"
C3-2 3/16" x 1/8"

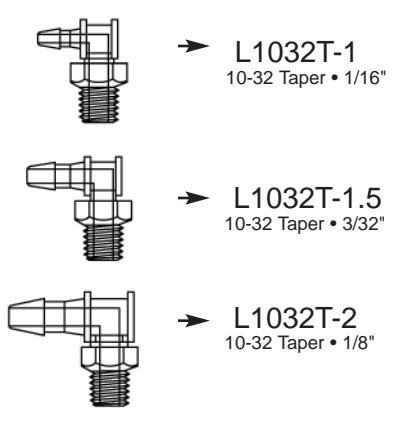
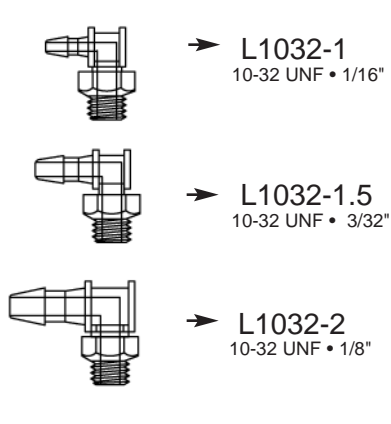
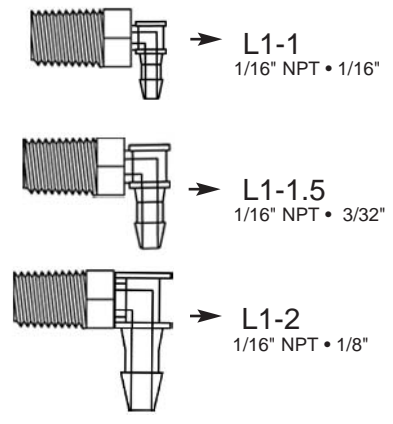

Not Illustrated

L1-2.5 1/16" NPT • 5/32"	L1-3 1/16" NPT • 3/16"
-----------------------------	---------------------------

Not Illustrated

T1-2.5 1/16" NPT • 5/32"	T1-3 1/16" NPT • 3/16"
-----------------------------	---------------------------

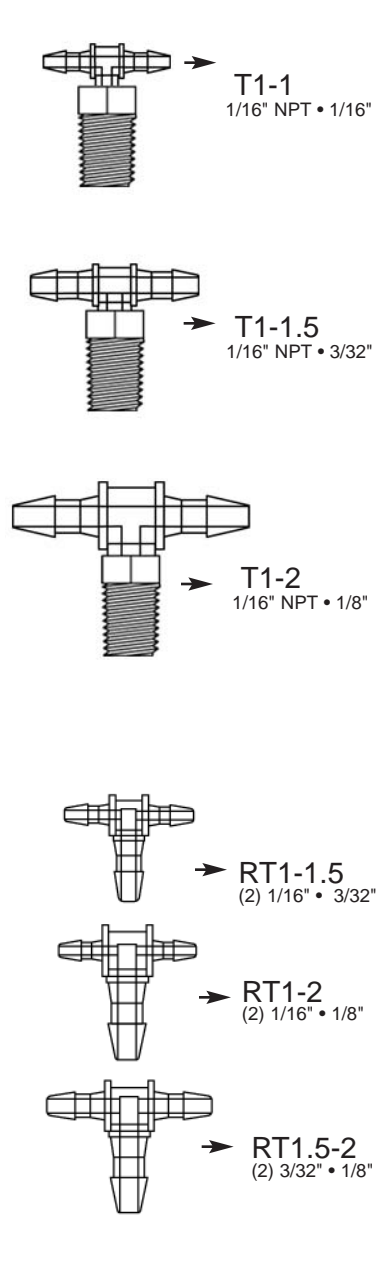
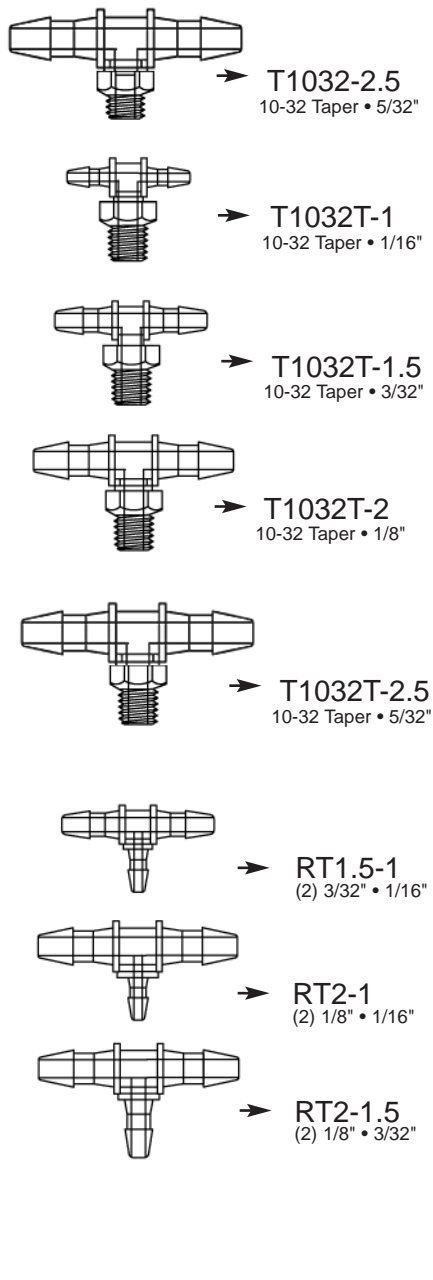
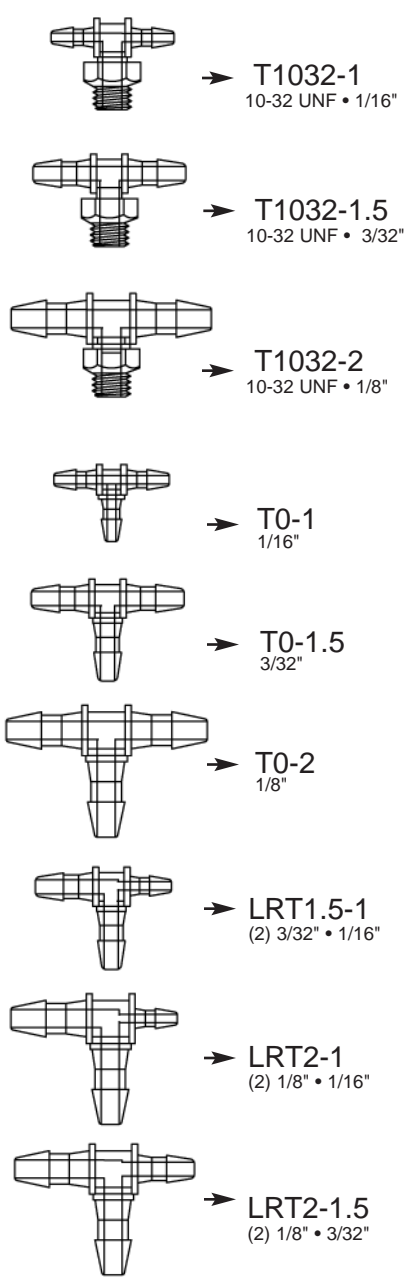

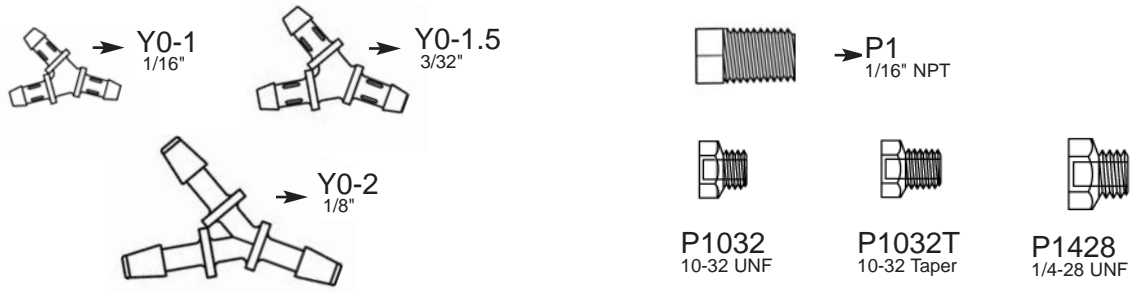

Female 10-32 UNF Threaded Miniature Fittings shown below are available in Natural Polypropylene and Black Nylon. Please call for quotes and lead time.

Female Elbow



1032F-L NP
1032F-L BN

Female Tee

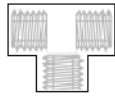

1032F-T NP
1032F-T BN

Junction

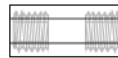

1032F-C NP
1032F-C BN

Female Cross

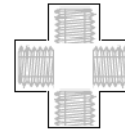

1032F-X NP
1032F-X BN

New Listings! 1/16" NPT Threaded Adapters, Elbows, Tees and Plugs

Part Number Size	Code	.	.	.
A1032-1	NN	.	.	.
10-32 UNF • 1/16"	NP	.	.	.
	NK	.	.	.
	HDPE	.	.	.
	BN	.	.	.

Part Number Size	Code	.	.	.
A1032T-1	NN	.	.	.
10-32 Taper • 1/16"	NP	.	.	.
	NK	.	.	.
	HDPE	.	.	.
	BN	.	.	.

Part Number Size	Code	.	.	.
A1032-1.5	NN	.	.	.
10-32 UNF • 3/32"	NP	.	.	.
	NK	.	.	.
	HDPE	.	.	.
	BN	.	.	.

Part Number Size	Code	.	.	.
A1032T-1.5	NN	.	.	.
10-32 Taper • 3/32"	NP	.	.	.
	NK	.	.	.
	HDPE	.	.	.
	BN	.	.	.

Part Number Size	Code	.	.	.
A1032-2	NN	.	.	.
10-32 UNF • 1/8"	NP	.	.	.
	NK	.	.	.
	HDPE	.	.	.
	BN	.	.	.

Part Number Size	Code	.	.	.
A1032T-2	NN	.	.	.
10-32 Taper • 1/8"	NP	.	.	.
	NK	.	.	.
	HDPE	.	.	.
	BN	.	.	.

Many miniature fittings sizes are also available in 100 and 500 piece quantities, molded in Gray Kynar® and White Polypropylene materials. Please refer to the Industrial Materials section of this catalog: pages 68-93.

***Natural Materials Fittings - NN, NK, NP and HDPE are non-returnable**

Please request samples prior to quantity purchasing for testing and evaluation in your application.

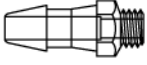
Part Number Size	Code	.	.	.
A1032-2.5	NN	.	.	.
10-32 UNF • 5/32"	NP	.	.	.
	NK	.	.	.
	HDPE	.	.	.
	BN	.	.	.

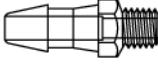
Part Number Size	Code	.	.	.
A1032T-2.5	NN	.	.	.
10-32 Taper • 5/32"	NP	.	.	.
	NK	.	.	.
	HDPE	.	.	.
	BN	.	.	.

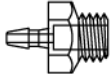
Part Number Size	Code	.	.	.
A1428-1	NN	.	.	.
1/4-28 UNF • 1/16"	NP	.	.	.
	NK	.	.	.
	HDPE	.	.	.
	BN	.	.	.

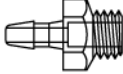
Part Number Size	Code	.	.	.
A1428-1.5	NN	.	.	.
1/4-28 UNF • 3/32"	NP	.	.	.
	NK	.	.	.
	HDPE	.	.	.
	BN	.	.	.

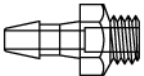
Part Number Size	Code	.	.	.
A1428-2	NN	.	.	.
1/4-28 UNF • 1/8"	NP	.	.	.
	NK	.	.	.
	HDPE	.	.	.
	BN	.	.	.

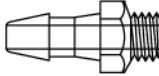
Part Number Size	Code	.	.	.
A1428-2.5	NN	.	.	.
1/4-28 UNF • 5/32"	NP	.	.	.
	NK	.	.	.
	HDPE	.	.	.
	BN	.	.	.

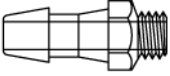
Part Number Size	Code	.	.	.
A1428-3	NN	.	.	.
1/4-28 UNF • 3/16"	NP	.	.	.
	NK	.	.	.
	HDPE	.	.	.
	BN	.	.	.

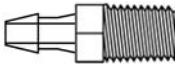
Part Number Size	Code	.	.	.
A1-2	NN	.	.	.
1/16" NPT • 1/8"	NP	.	.	.
	NK	.	.	.
	HDPE	.	.	.
	BN	.	.	.

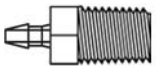
Part Number Size	Code	.	.	.
A1-1	NN	.	.	.
1/16" NPT • 1/16"	NP	.	.	.
	NK	.	.	.
	HDPE	.	.	.
	BN	.	.	.

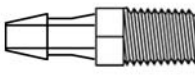
Part Number Size	Code	.	.	.
A1-2.5	NN	.	.	.
1/16" NPT • 5/32"	NP	.	.	.
	NK	.	.	.
	HDPE	.	.	.
	BN	.	.	.

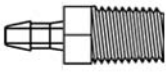
Part Number Size	Code	.	.	.
A1-1.5	NN	.	.	.
1/16" NPT • 3/32"	NP	.	.	.
	NK	.	.	.
	HDPE	.	.	.
	BN	.	.	.

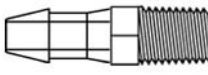
Part Number Size	Code	.	.	.
A1-3	NN	.	.	.
1/16" NPT • 3/16"	NP	.	.	.
	NK	.	.	.
	HDPE	.	.	.
	BN	.	.	.

High Density Natural Polyethylene > **HDPE**
 Natural Polypropylene > **NP** Natural Nylon > **NN** Natural Kynar® > **NK** Black Nylon > **BN**

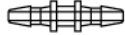
Part Number Size	Code	.	.	.
C0-1	NN	.	.	.
1/16"	NP	.	.	.
	NK	.	.	.
	HDPE	.	.	.
	BN	.	.	.

Part Number Size	Code	.	.	.
C0-1.5	NN	.	.	.
3/32"	NP	.	.	.
	NK	.	.	.
	HDPE	.	.	.
	BN	.	.	.

Part Number Size	Code	.	.	.
C0-2	NN	.	.	.
1/8"	NP	.	.	.
	NK	.	.	.
	HDPE	.	.	.
	BN	.	.	.

Part Number Size	Code	.	.	.
C2.5-1	NN	.	.	.
5/32" • 1/16"	NP	.	.	.
	NK	.	.	.
	HDPE	.	.	.
	BN	.	.	.

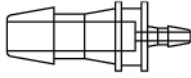
Part Number Size	Code	.	.	.
C3-1	NN	.	.	.
3/16" • 1/16"	NP	.	.	.
	NK	.	.	.
	HDPE	.	.	.
	BN	.	.	.

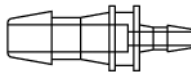
Part Number Size	Code	.	.	.
C3-1.5	NN	.	.	.
3/16" • 3/32"	NP	.	.	.
	NK	.	.	.
	HDPE	.	.	.
	BN	.	.	.

Part Number Size	Code	.	.	.
C3-2.5	NN	.	.	.
3/16" • 5/32"	NP	.	.	.
	NK	.	.	.
	HDPE	.	.	.
	BN	.	.	.

Part Number Size	Code	.	.	.
C1.5-1	NN	.	.	.
3/32" • 1/16"	NP	.	.	.
	NK	.	.	.
	HDPE	.	.	.
	BN	.	.	.

Part Number Size	Code	.	.	.
C2-1	NN	.	.	.
1/8" • 1/16"	NP	.	.	.
	NK	.	.	.
	HDPE	.	.	.
	BN	.	.	.

Part Number Size	Code	.	.	.
C2-1.5	NN	.	.	.
1/8" • 3/32"	NP	.	.	.
	NK	.	.	.
	HDPE	.	.	.
	BN	.	.	.

Part Number Size	Code	.	.	.
C2.5-1.5	NN	.	.	.
5/32" • 3/32"	NP	.	.	.
	NK	.	.	.
	HDPE	.	.	.
	BN	.	.	.

Part Number Size	Code	.	.	.
L0-1	NN	.	.	.
1/16"	NP	.	.	.
	NK	.	.	.
	HDPE	.	.	.
	BN	.	.	.

Part Number Size	Code	.	.	.
L0-1.5	NN	.	.	.
3/32"	NP	.	.	.
	NK	.	.	.
	HDPE	.	.	.
	BN	.	.	.

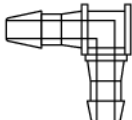
Part Number Size	Code	.	.	.
L0-2	NN	.	.	.
	NP	.	.	.
	NK	.	.	.
	HDPE	.	.	.
	BN	.	.	.

Part Number Size	Code	.	.	.
L1032-1	NN	.	.	.
10-32 UNF • 1/16"	NP	.	.	.
	NK	.	.	.
	HDPE	.	.	.
	BN	.	.	.

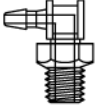
Part Number Size	Code	.	.	.
L1032T-1	NN	.	.	.
10-32 Taper • 1/16"	NP	.	.	.
	NK	.	.	.
	HDPE	.	.	.
	BN	.	.	.

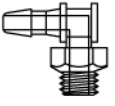
Part Number Size	Code	.	.	.
L1032-1.5	NN	.	.	.
10-32 UNF • 3/32"	NP	.	.	.
	NK	.	.	.
	HDPE	.	.	.
	BN	.	.	.

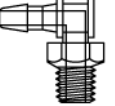
Part Number Size	Code	.	.	.
L1032T-1.5	NN	.	.	.
10-32 Taper • 3/32"	NP	.	.	.
	NK	.	.	.
	HDPE	.	.	.
	BN	.	.	.

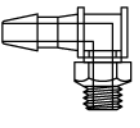
Part Number Size	Code	.	.	.
L1032-2	NN	.	.	.
10-32 UNF • 1/8"	NP	.	.	.
	NK	.	.	.
	HDPE	.	.	.
	BN	.	.	.

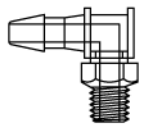
Part Number Size	Code	.	.	.
L1032T-2	NN	.	.	.
10-32 Taper • 1/8"	NP	.	.	.
	NK	.	.	.
	HDPE	.	.	.
	BN	.	.	.

For 1/16" NPT Elbows L1-1 L1-1.5 L1-2 L1-2.5 L1-3 sizes: see catalog listings by material

Part Number Size	Code	.	.	.
RL1.5-1	NN	.	.	.
3/32" • 1/16"	NP	.	.	.
	NK	.	.	.
	HDPE	.	.	.
	BN	.	.	.

Part Number Size	Code	.	.	.
X0-1	NN	.	.	.
1/16" 	NP	.	.	.
	NK	.	.	.
	HDPE	.	.	.
	BN	.	.	.

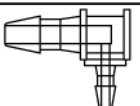
Part Number Size	Code	.	.	.
RL2-1	NN	.	.	.
1/8" • 1/16"	NP	.	.	.
	NK	.	.	.
	HDPE	.	.	.
	BN	.	.	.

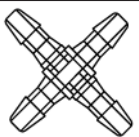
Part Number Size	Code	.	.	.
X0-1.5	NN	.	.	.
3/32" 	NP	.	.	.
	NK	.	.	.
	HDPE	.	.	.
	BN	.	.	.

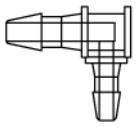
Part Number Size	Code	.	.	.
RL2-1.5	NN	.	.	.
1/8" • 3/32"	NP	.	.	.
	NK	.	.	.
	HDPE	.	.	.
	BN	.	.	.

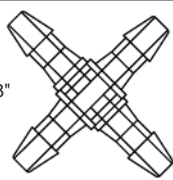
Part Number Size	Code	.	.	.
X0-2	NN	.	.	.
1/8" 	NP	.	.	.
	NK	.	.	.
	HDPE	.	.	.
	BN	.	.	.

High Density Natural Polyethylene > HDPE

Natural Polypropylene > NP Natural Nylon > NN Natural Kynar® > NK Black Nylon > BN

Plugs - Insert

Part Number Size	Code	.	.	.
P0-1	NN	.	.	.
1/16"	NP	.	.	.
	NK	.	.	.
	HDPE	.	.	.
	BN	.	.	.

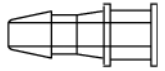
Part Number Size	Code	.	.	.
P0-2.5	NN	.	.	.
5/32"	NP	.	.	.
	NK	.	.	.
	HDPE	.	.	.
	BN	.	.	.

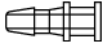
Part Number Size	Code	.	.	.
P0-1.5	NN	.	.	.
3/32"	NP	.	.	.
	NK	.	.	.
	HDPE	.	.	.
	BN	.	.	.

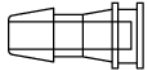
Part Number Size	Code	.	.	.
P0-3	NN	.	.	.
3/16"	NP	.	.	.
	NK	.	.	.
	HDPE	.	.	.
	BN	.	.	.

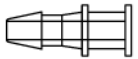
Part Number Size	Code	.	.	.
P0-2	NN	.	.	.
1/8"	NP	.	.	.
	NK	.	.	.
	HDPE	.	.	.
	BN	.	.	.

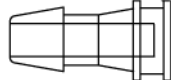
Part Number Size	Code	.	.	.
P0-4	NN	.	.	.
1/4"	NP	.	.	.
	NK	.	.	.
	HDPE	.	.	.
	BN	.	.	.

Plugs - Threaded

Part Number Size	Code	.	.	.
P1032	NN	.	.	.
10-32 UNF	NP	.	.	.
	NK	.	.	.
	HDPE	.	.	.
	BN	.	.	.

Part Number Size	Code	.	.	.
P1428	NN	.	.	.
1/4-28 UNF	NP	.	.	.
	NK	.	.	.
	HDPE	.	.	.
	BN	.	.	.

Part Number Size	Code	.	.	.
P1032T	NN	.	.	.
10-32 Taper	NP	.	.	.
	NK	.	.	.
	HDPE	.	.	.
	BN	.	.	.

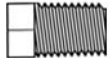
Part Number Size	Code	.	.	.
P1	NN	.	.	.
1/16" NPT	NP	.	.	.
	NK	.	.	.
	HDPE	.	.	.
	BN	.	.	.

Tees - Asymmetric

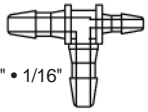
Part Number Size	Code	.	.	.
LRT1.5-1	NN	.	.	.
 (2) 3/32" • 1/16"	NP	.	.	.
	NK	.	.	.
	HDPE	.	.	.
	BN	.	.	.

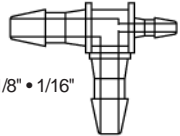
Part Number Size	Code	.	.	.
LRT2-1	NN	.	.	.
 (2) 1/8" • 1/16"	NP	.	.	.
	NK	.	.	.
	HDPE	.	.	.
	BN	.	.	.

Tees - Asymmetric

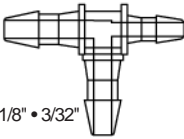
Part Number Size	Code	.	.	.
LRT2-1.5	NN	.	.	.
 (2) 1/8" • 3/32"	NP	.	.	.
	NK	.	.	.
	HDPE	.	.	.
	BN	.	.	.

Tees - Equal

Part Number Size	Code	.	.	.
T0-1	NN	.	.	.
1/16"	NP	.	.	.
	NK	.	.	.
	HDPE	.	.	.
	BN	.	.	.

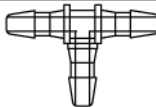
Part Number Size	Code	.	.	.
T0-1.5	NN	.	.	.
3/32"	NP	.	.	.
	NK	.	.	.
	HDPE	.	.	.
	BN	.	.	.

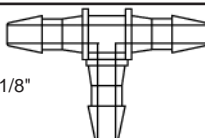
Part Number Size	Code	.	.	.
T0-2	NN	.	.	.
 1/8"	NP	.	.	.
	NK	.	.	.
	HDPE	.	.	.
	BN	.	.	.

Tees - Reduction

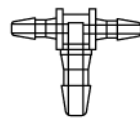
Part Number Size	Code	.	.	.
RT1-1.5	NN	.	.	.
(2) 1/16" • 3/32"	NP	.	.	.
	NK	.	.	.
	HDPE	.	.	.
	BN	.	.	.

Tees - Threaded

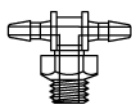
Part Number Size	Code	.	.	.
T1032-1	NN	.	.	.
10-32 UNF • 1/16"	NP	.	.	.
	NK	.	.	.
	HDPE	.	.	.
	BN	.	.	.

Tees - Reduction

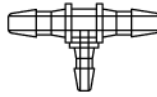
Part Number Size	Code	.	.	.
RT-1.5-1	NN	.	.	.
(2) 3/32" • 1/16"	NP	.	.	.
	NK	.	.	.
	HDPE	.	.	.
	BN	.	.	.

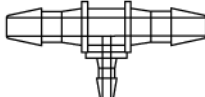
Part Number Size	Code	.	.	.
RT2-1	NN	.	.	.
(2) 1/8" • 1/16"	NP	.	.	.
	NK	.	.	.
	HDPE	.	.	.
	BN	.	.	.

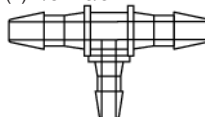
Part Number Size	Code	.	.	.
RT2-1.5	NN	.	.	.
(2) 1/8" • 3/32"	NP	.	.	.
	NK	.	.	.
	HDPE	.	.	.
	BN	.	.	.

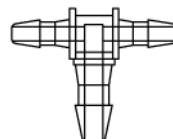
Part Number Size	Code	.	.	.
RT1.5-2	NN	.	.	.
(2) 3/32" • 1/8"	NP	.	.	.
	NK	.	.	.
	HDPE	.	.	.
	BN	.	.	.

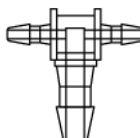
Part Number Size	Code	.	.	.
RT1-2	NN	.	.	.
(2) 1/16" • 1/8"	NP	.	.	.
	NK	.	.	.
	HDPE	.	.	.
	BN	.	.	.

Taper - Threaded

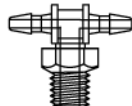
Part Number Size	Code	.	.	.
T1032T-1	NN	.	.	.
10-32 Taper • 1/16"	NP	.	.	.
	NK	.	.	.
	HDPE	.	.	.
	BN	.	.	.

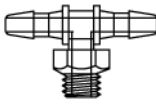
Part Number Size	Code	.	.	.
T1032-1.5 10-32 UNF • 3/32" 	NN	.	.	.
	NP	.	.	.
	NK	.	.	.
	HDPE	.	.	.
	BN	.	.	.

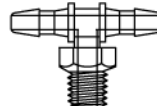
Part Number Size	Code	.	.	.
T1032T-1.5 10-32 Taper • 3/32" 	NN	.	.	.
	NP	.	.	.
	NK	.	.	.
	HDPE	.	.	.
	BN	.	.	.

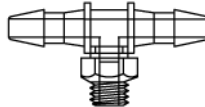
Part Number Size	Code	.	.	.
T1032-2 10-32 UNF • 1/8" 	NN	.	.	.
	NP	.	.	.
	NK	.	.	.
	HDPE	.	.	.
	BN	.	.	.

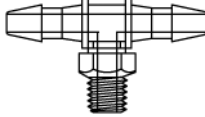
Part Number Size	Code	.	.	.
T1032T-2 10-32 Taper • 1/8" 	NN	.	.	.
	NP	.	.	.
	NK	.	.	.
	HDPE	.	.	.
	BN	.	.	.

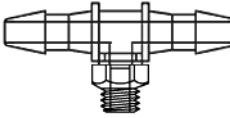
Part Number Size	Code	.	.	.
T1032-2.5 10-32 UNF • 5/32" 	NN	.	.	.
	NP	.	.	.
	NK	.	.	.
	HDPE	.	.	.
	BN	.	.	.

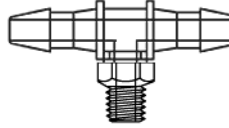
Part Number Size	Code	.	.	.
T1032T-2.5 10-32 Taper • 5/32" 	NN	.	.	.
	NP	.	.	.
	NK	.	.	.
	HDPE	.	.	.
	BN	.	.	.

Part Number Size	Code	.	.	.
T1-1 1/16" NPT • 1/16" 	NN	.	.	.
	NP	.	.	.
	NK	.	.	.
	HDPE	.	.	.
	BN	.	.	.

Part Number Size	Code	.	.	.
Y0-1 1/16" 	NN	.	.	.
	NP	.	.	.
	NK	.	.	.
	HDPE	.	.	.
	BN	.	.	.

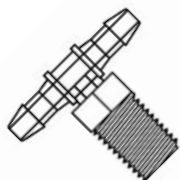
Part Number Size	Code	.	.	.
T1-1.5 1/16" NPT • 3/32" 	NN	.	.	.
	NP	.	.	.
	NK	.	.	.
	HDPE	.	.	.
	BN	.	.	.

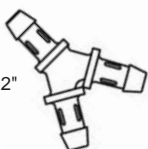
Part Number Size	Code	.	.	.
Y0-1.5 3/32" 	NN	.	.	.
	NP	.	.	.
	NK	.	.	.
	HDPE	.	.	.
	BN	.	.	.

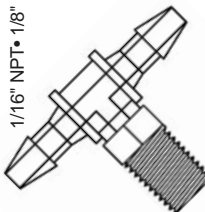
Part Number Size	Code	.	.	.
T1-2 1/16" NPT • 1/8" 	NN	.	.	.
	NP	.	.	.
	NK	.	.	.
	HDPE	.	.	.
	BN	.	.	.
T1-2.5 and T1-3 sizes: see catalog listings by material				

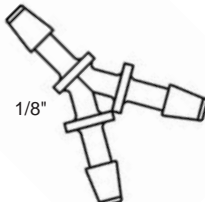
Part Number Size	Code	.	.	.
Y0-2 1/8" 	NN	.	.	.
	NP	.	.	.
	NK	.	.	.
	HDPE	.	.	.
	BN	.	.	.

Custom Configuration Options

The following pages offer custom configuration options for a number of miniature fittings designs: Pages 106-112

The Custom Fittings Section on our Website contains a utility that automatically generates part numbers for selected custom options.

www.eldonjames.com

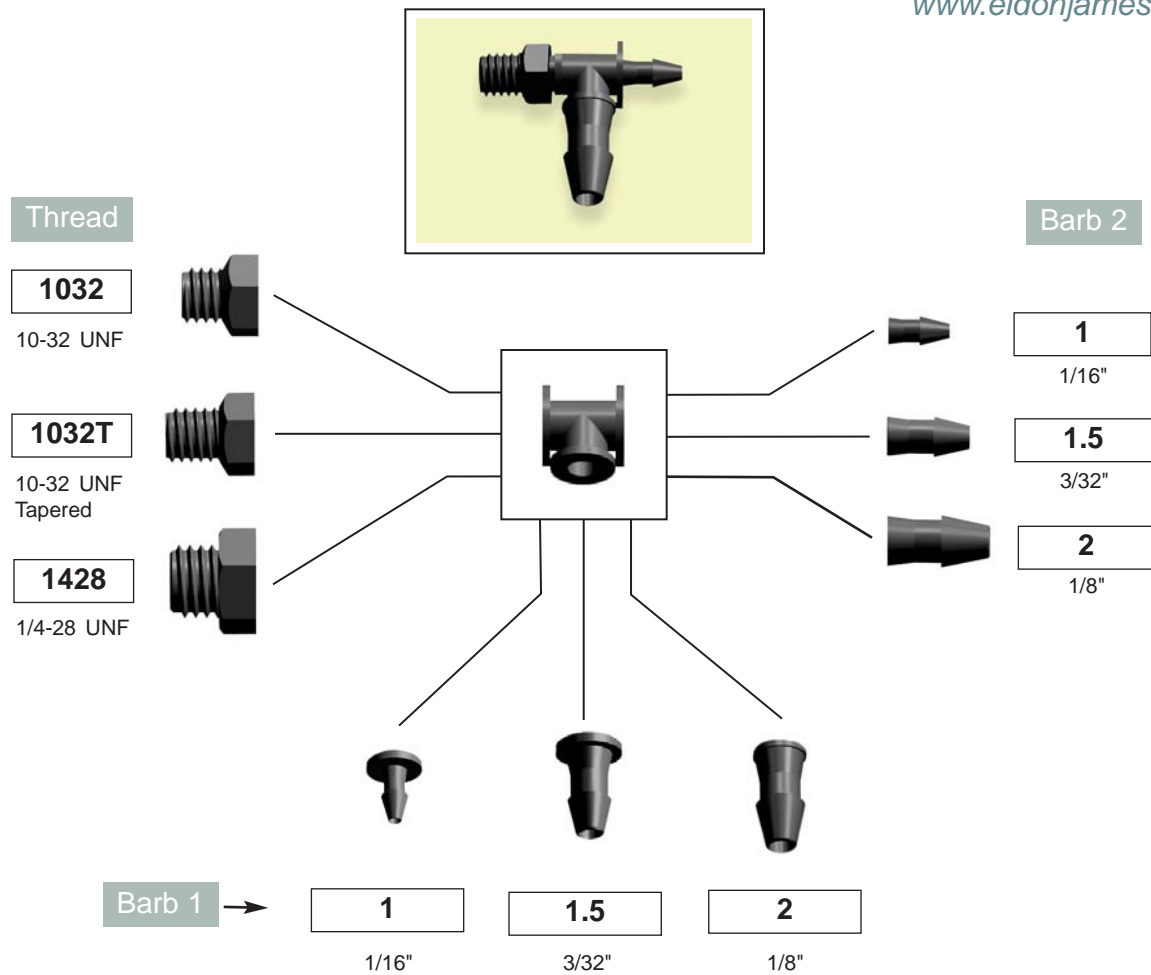

NN > Natural Nylon **NK** > Natural Kynar® **NP** > Natural Polypropylene
HDPE > Natural High Density Polyethylene **WN** > White Nylon **BN** > Black Nylon



Please call for quotes on custom options

Miniature Couplers / Reduction Couplers and Custom Options

Example: **C0 -1.5 NN**

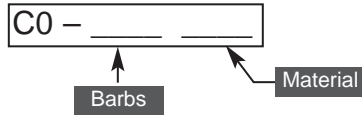

Equal Coupler

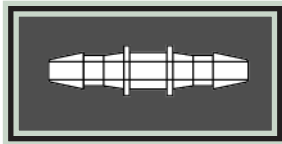

Barb 1 equal to barb 2

All Equal Coupler configurations are standard

Example: **C 2-1.5 NN**

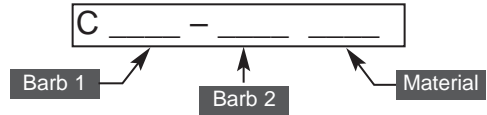

Reduction Coupler

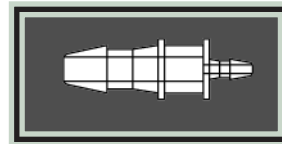

Barb 1 must be larger than barb 2

Reduction Coupler Sizes
(1/4" x 1/16") and (1/4" x 3/32")
are custom options

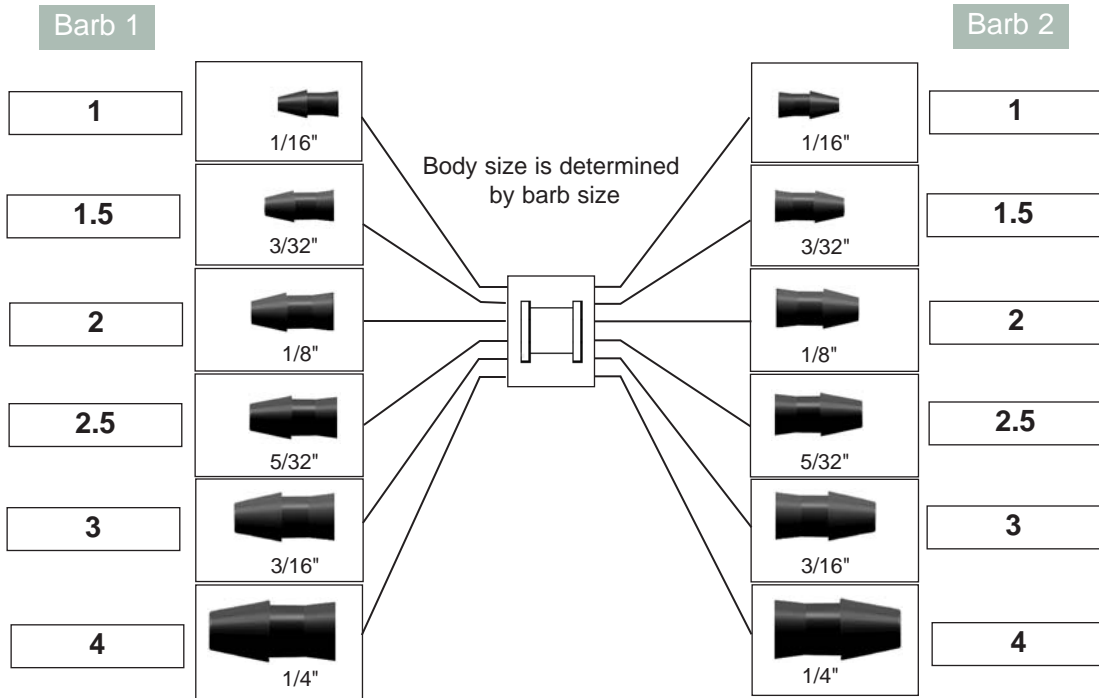

Material Options:

NN > Natural Nylon **NK** > Natural Kynar® **NP** > Natural Polypropylene
HDPE > Natural High Density Polyethylene **WN** > White Nylon **BN** > Black Nylon

Miniature Reduction Elbows and Custom Options

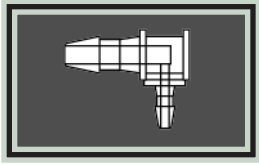

Reduction Elbows

Example: **RL 2-1.5 NN**

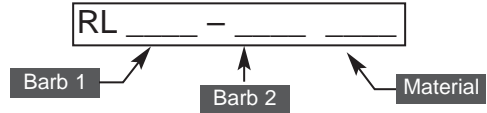

Barbed Reduction Elbow

Barb 1 must be larger than Barb 2

All Reduction Elbow Fittings with 5/32" (2.5 Barb)
 3/16" (3 Barb)
 1/4" (4 Barb)
 are custom options

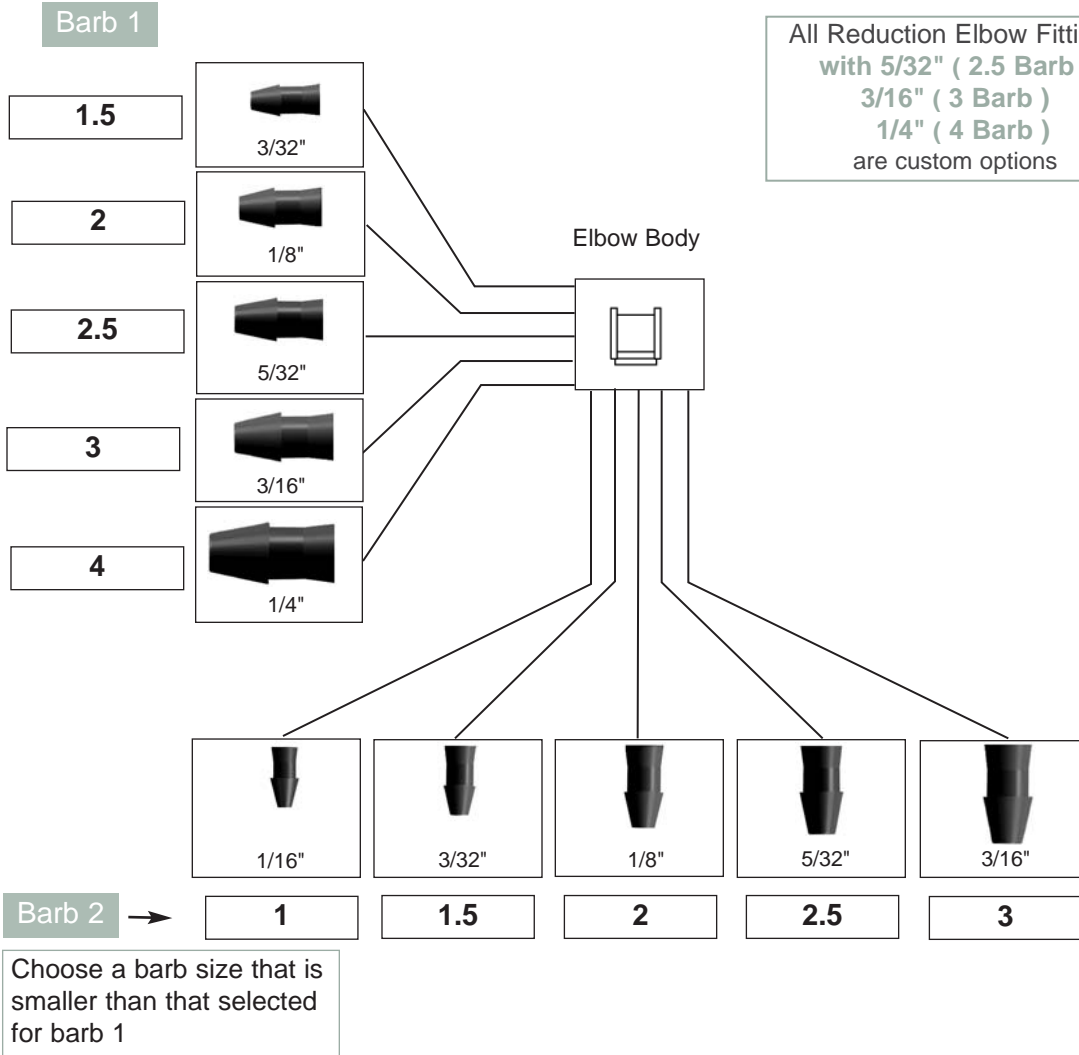

Material Options:

NN > Natural Nylon **NK** > Natural Kynar® **NP** > Natural Polypropylene
HDPE > Natural High Density Polyethylene **WN** > White Nylon **BN** > Black Nylon

Miniature Threaded Elbows and Custom Options

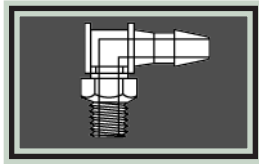

Threaded Elbows

Example: L 1032T - 2 NN

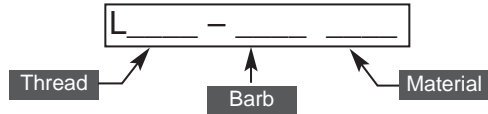

Threaded Elbow

Custom Options:
 10-32 and 1032T Elbows with
 5/32" - (2.5 Barb) or 3/16" - (3 Barb)
 and all 1/4-28 Threaded Elbows

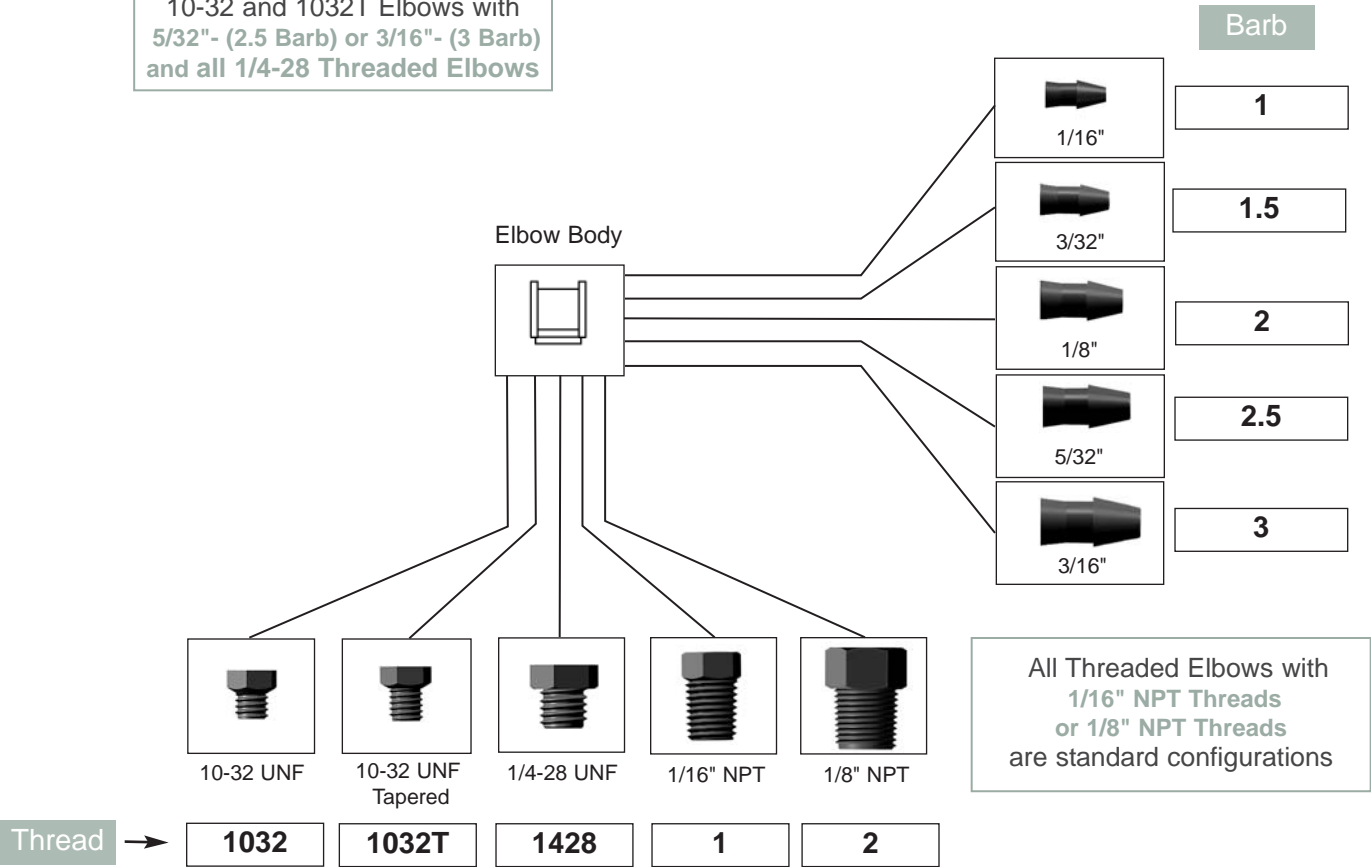

All Threaded Elbows with
 1/16" NPT Threads
 or 1/8" NPT Threads
 are standard configurations

Material Options:

NN > Natural Nylon **NK** > Natural Kynar® **NP** > Natural Polypropylene
HDPE > Natural High Density Polyethylene **WN** > White Nylon **BN** > Black Nylon

Branched Tee Fittings Custom Options

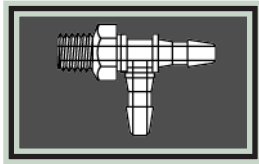

Branched Tee (TB)

Example: **TB 1032 - 2 - 1.5 NN**

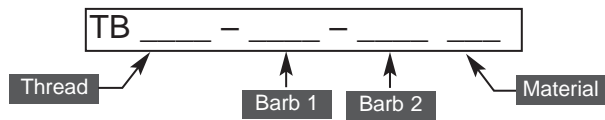

All Branched Tee Fittings are
Custom Options

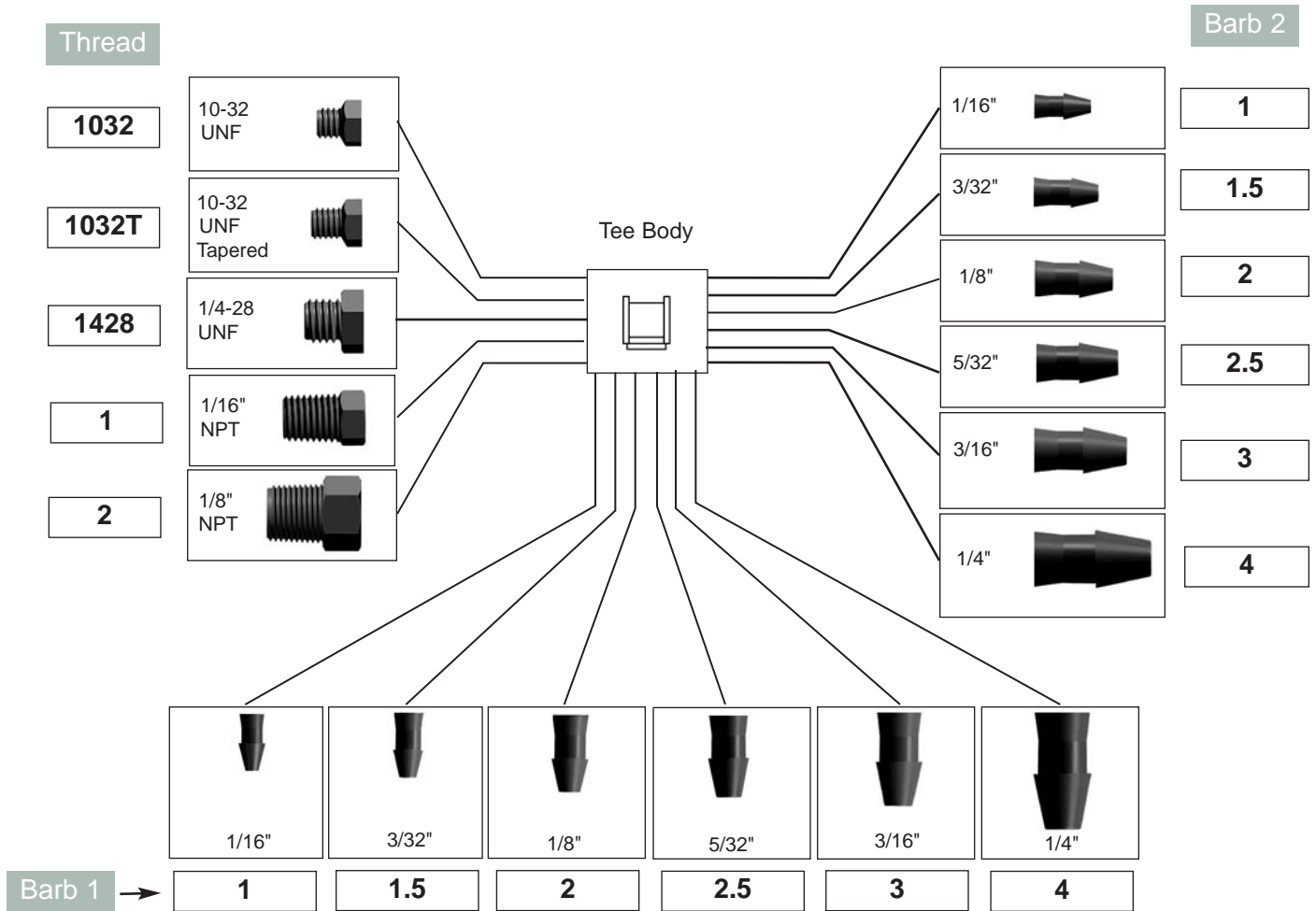

Material Options:

NN > Natural Nylon **NK** > Natural Kynar® **NP** > Natural Polypropylene
HDPE > Natural High Density Polyethylene **WN** > White Nylon **BN** > Black Nylon

Miniature Threaded Tee Fittings and Asymmetric Threaded Tee Custom Options

Example: **T 1032 - 1.5 NN**

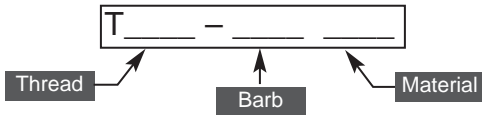

Threaded Tee - Equal Barbs

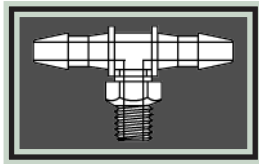

Custom Options:
10-32 and 1032T Tees with
5/32" - (2.5 Barb) or 3/16" - (3 Barb)
and all 1/4-28 Threaded Tees

Example: **TA 1032 - 1.5 - 1 NN**

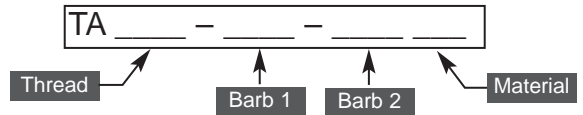

TA Tee - Asymmetric Barbs
Barb 1 must be larger than barb 2

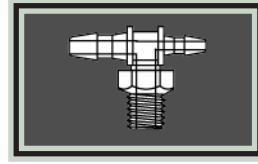

All Threaded Asymmetric
Tees are
Custom Options

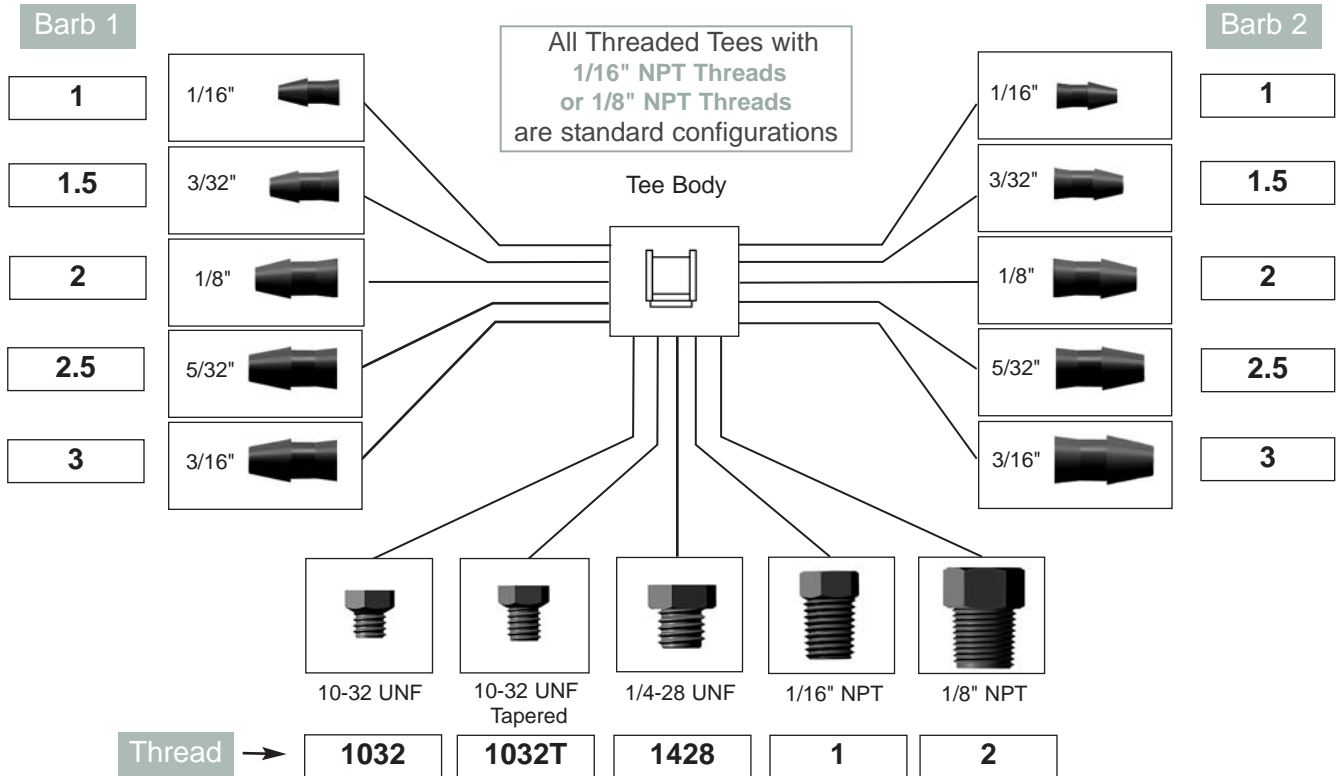

Material Options:

NN > Natural Nylon **NK** > Natural Kynar® **NP** > Natural Polypropylene
HDPE > Natural High Density Polyethylene **WN** > White Nylon **BN** > Black Nylon

Asymmetric Cross Custom Options

Example: **XA 2 - 1.5 - 1 - 2 NN**

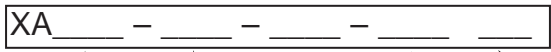

XA - Asymmetric Cross

All Asymmetric Cross Fittings are custom configurations

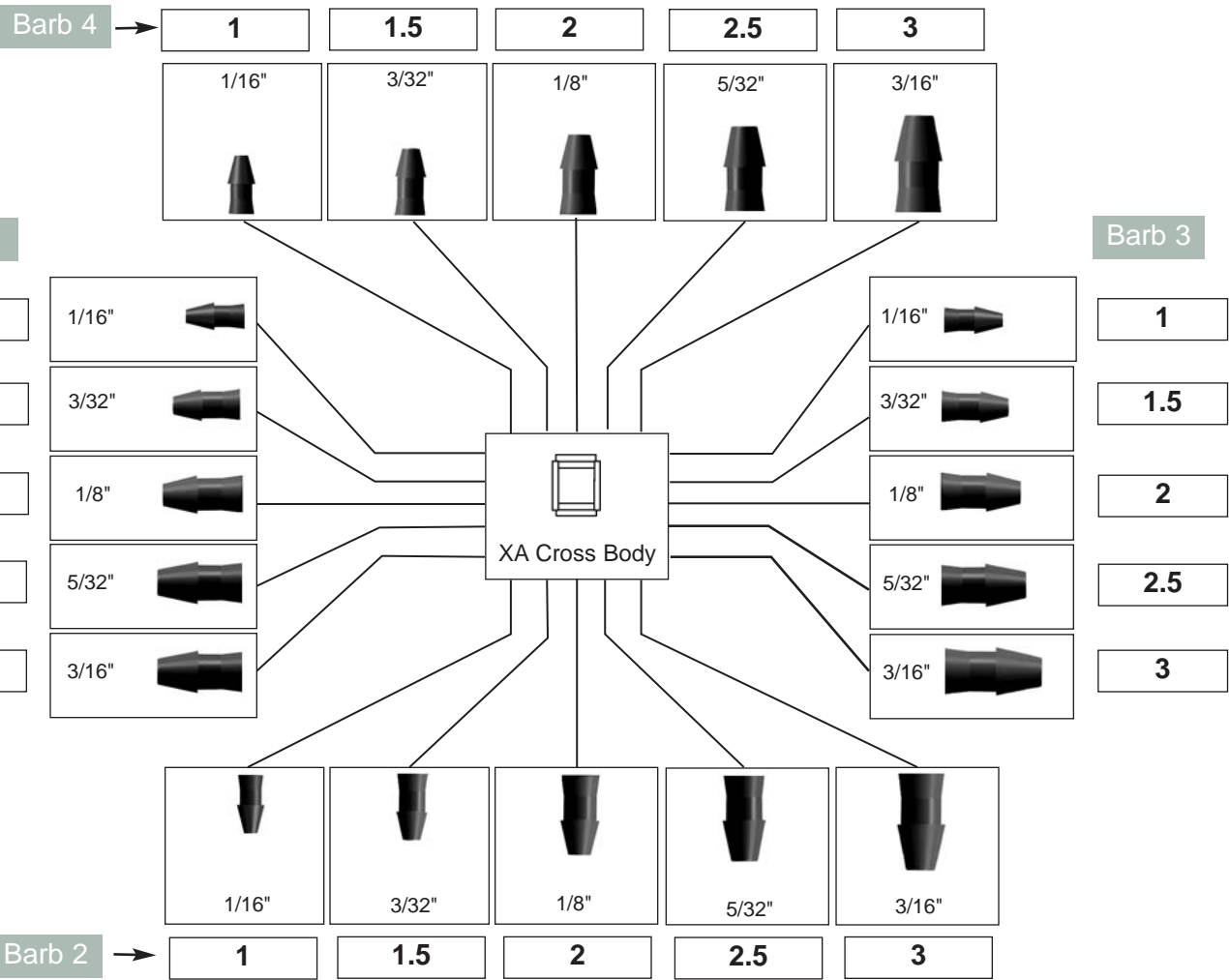
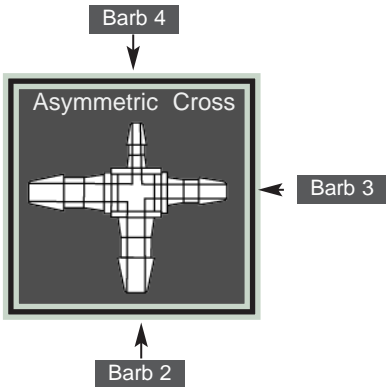

Design Note: 1/4" (4 Barbs) may be added at any position

Material Options:

NN > Natural Nylon **NK** > Natural Kynar® **NP** > Natural Polypropylene
HDPE > Natural High Density Polyethylene **WN** > White Nylon **BN** > Black Nylon

Asymmetric Threaded Cross Custom Options

Example: X **1032T** - 1 - 1 - 2 **NN**

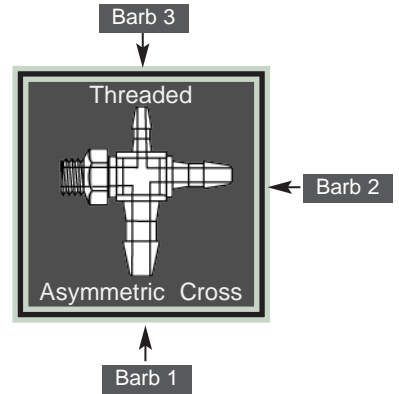
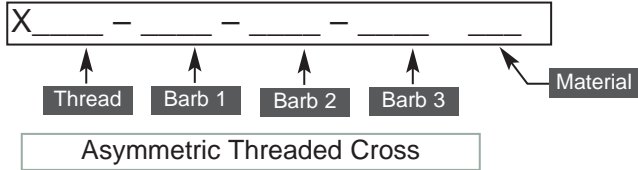

All Asymmetric Threaded Cross Fittings are custom configurations

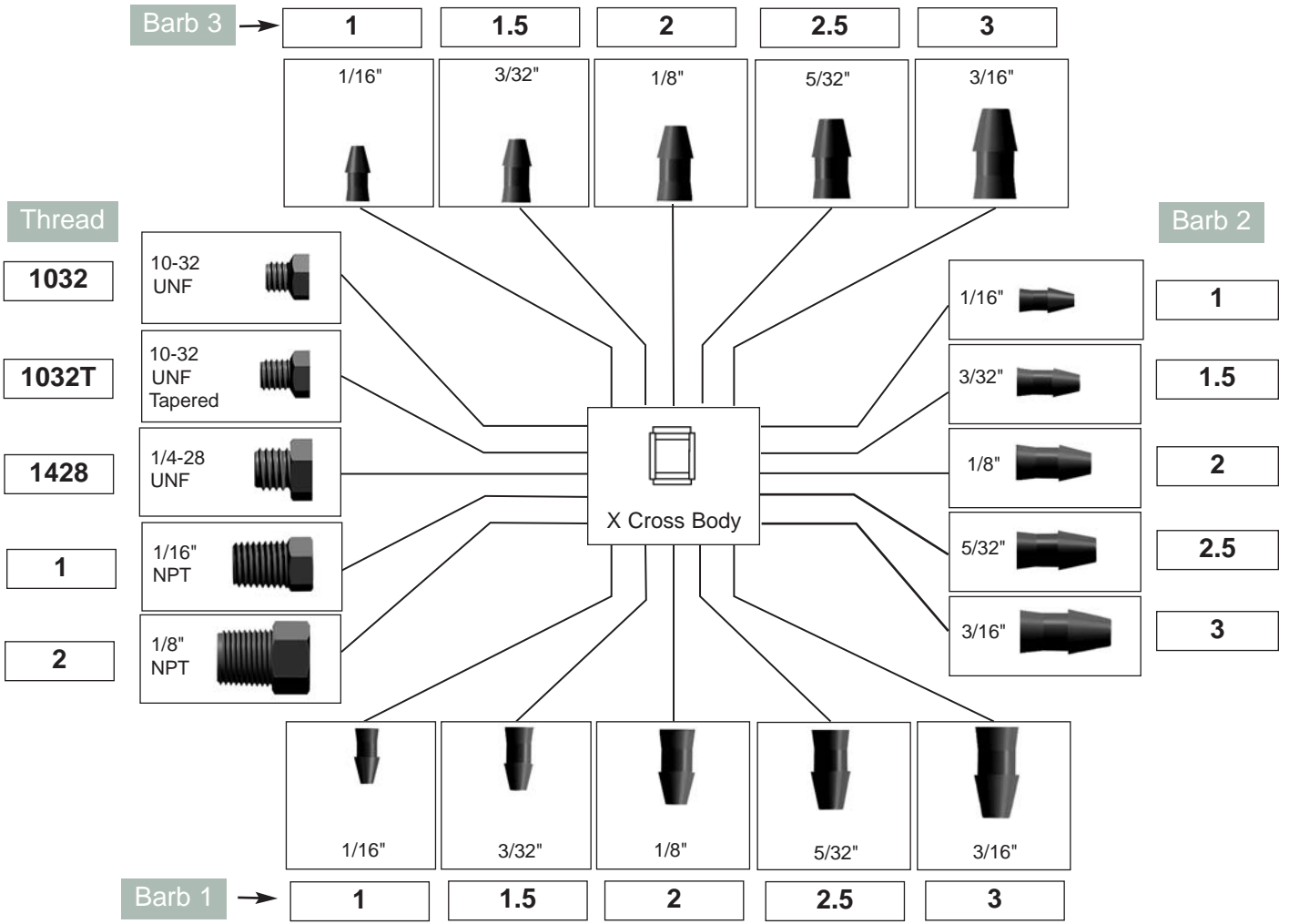

Design Note: 1/4" (4 Barbs) may also be added at any barb position

Material Options:

NN > Natural Nylon **NK** > Natural Kynar® **NP** > Natural Polypropylene
HDPE > Natural High Density Polyethylene **WN** > White Nylon **BN** > Black Nylon

Luers - Standard
RoHS Compliant



Male



Female

▷ USP Class VI

Materials



Standard Size Luers			Animal Derivative Free		Animal Derivative Free		
Size	Description	Part Number	PP	PPAG	NN	MN	MNAG
1/16"	Male Luer	LM-1	▷	•	•	•	•
1/16"	Female Luer	LF-1	▷	•	•	•	•
3/32"	Male Luer	LM-1.5	▷	•	•	•	•
3/32"	Female Luer	LF-1.5	▷	•	•	•	•
1/8"	Male Luer	LM-2	▷	•	•	•	•
1/8"	Female Luer	LF-2	▷	•	•	•	•
5/32"	Male Luer	LM-2.5	▷	•	•	•	•
5/32"	Female Luer	LF-2.5	▷	•	•	•	•
3/16"	Male Luer	LM-3	▷	•	•	•	•
3/16"	Female Luer	LF-3	▷	•	•	•	•
1/4"	Male Luer	LM-4	▷	•	•	•	•
1/4"	Female Luer	LF-4	▷	•	•	•	•

PP Polypropylene PP	Natural Nylon NN	PPAG PP Polypropylene (Antimicrobial Protected)
White Medical Nylon MN		MNAG MN Medical Nylon (Antimicrobial Protected)

Antimicrobial (Protected) • PPAG and MNAG Luers PPAG MNAG

- Silver ions protect fittings from bio-film formation and colonization by microbes
- Effective on a broad range of microbes, including many harmful strains of bacteria
- Silver ion protection interferes with respiratory and metabolic functions of microbes
- An environmentally sustainable solution that does not rely on toxic chemicals

Luers - Large Bore
RoHS Compliant



Large Bore Male



Large Bore Female

▷ USP Class VI

Materials



Large Bore Luers			Animal Derivative Free		Animal Derivative Free		
Size	Description	Part Number	PP	PPAG	NN	MN	MNAG
3/16"	Large Bore Male	LBLM-3	▷	•	•	•	•
3/16"	Large Bore Female	LBLF-3	▷	•	•	•	•
1/4"	Large Bore Male	LBLM-4	▷	•	•	•	•
1/4"	Large Bore Female	LBLF-4	▷	•	•	•	•
5/16"	Large Bore Male	LBLM-5	▷	•	•	•	•
5/16"	Large Bore Female	LBLF-5	▷	•	•	•	•

PP Polypropylene PP	Natural Nylon NN	PPAG PP Polypropylene (Antimicrobial Protected)
White Medical Nylon MN		MNAG MN Medical Nylon (Antimicrobial Protected)

PP and PPAG materials contain no components of animal origin



Luer Coupler		_ Animal Derivative Free		_ Animal Derivative Free			
Size	Description	Part Number	PP	PPAG	NN	MN	MNAG
Standard	Female Coupler	LF-C	▷	•	•	•	•



Female Slip		_ Animal Derivative Free		_ Animal Derivative Free			
Size	Description	Part Number	PP	PPAG	NN	MN	MNAG
Standard	Luer Female Slip	LSL	▷	•	•	•	•



Female Plug		_ Animal Derivative Free		_ Animal Derivative Free			
Size	Description	Part Number	PP	PPAG	NN	MN	MNAG
Standard	Luer Female Plug	LF-P	▷	•	•	•	•



Male Plug		_ Animal Derivative Free		_ Animal Derivative Free			
Size	Description	Part Number	PP	PPAG	NN	MN	MNAG
Standard	Luer Male Plug	LM-P	▷	•	•	•	•



Locking Plug		_ Animal Derivative Free		_ Animal Derivative Free			
Size	Description	Part Number	PP	PPAG	NN	MN	MNAG
Standard	Male Stationary Plug	LMSL-P	▷	•	•	•	•



Rotating Plug		_ Animal Derivative Free		_ Animal Derivative Free			
Size	Description	Part Number	PP	PPAG	NN	MN	MNAG
Standard	Male Rotating Plug	LMRL-P	▷	•	•	•	•



Slip Plug		_ Animal Derivative Free		_ Animal Derivative Free			
Size	Description	Part Number	PP	PPAG	NN	MN	MNAG
Standard	Male Slip Plug	LMS-P	▷	•	•	•	•



Large Bore Plug		_ Animal Derivative Free		_ Animal Derivative Free			
Size	Description	Part Number	PP	PPAG	NN	MN	MNAG
Large Bore	Female LB Plug	LBLF-P	▷	•	•	•	•



Large Bore Plug		_ Animal Derivative Free		_ Animal Derivative Free			
Size	Description	Part Number	PP	PPAG	NN	MN	MNAG
Large Bore	Male LB Plug	LBLM-P	▷	•	•	•	•

Luers - Slip Luers
RoHS Compliant

▷ USP Class VI

ISO 9001
Quality System



Slip Luers							
Animal Derivative Free				Animal Derivative Free			
Size	Description	Part Number	PP	PPAG	NN	MN	MNAG
1/16"	Male Slip Luer	LMS-1	▷	•	•	•	•
3/32"	Male Slip Luer	LMS-1.5	▷	•	•	•	•
1/8"	Male Slip Luer	LMS-2	▷	•	•	•	•
5/32"	Male Slip Luer	LMS-2.5	▷	•	•	•	•
3/16"	Male Slip Luer	LMS-3	▷	•	•	•	•
1/4"	Male Slip Luer	LMS-4	▷	•	•	•	•



Luers - Stationary Lock Luers
RoHS Compliant

▷ USP Class VI

Stationary Lock Luers							
Animal Derivative Free				Animal Derivative Free			
Size	Description	Part Number	PP	PPAG	NN	MN	MNAG
1/16"	Male Stationary Lock	LMSL-1	▷	•	•	•	•
3/32"	Male Stationary Lock	LMSL-1.5	▷	•	•	•	•
1/8"	Male Stationary Lock	LMSL-2	▷	•	•	•	•
5/32"	Male Stationary Lock	LMSL-2.5	▷	•	•	•	•
3/16"	Male Stationary Lock	LMSL-3	▷	•	•	•	•
1/4"	Male Stationary Lock	LMSL-4	▷	•	•	•	•

Use with Snap Lock pictured below



Luers - Rotating Lock Luers
RoHS Compliant

Rotating barb assembly using LMRL and LSLR components

Rotating Lock Luers							
Animal Derivative Free				Animal Derivative Free			
Size	Description	Part Number	PP	PPAG	NN	MN	MNAG
1/16"	Male Rotating Lock	LMRL-1	▷	•	•	•	•
3/32"	Male Rotating Lock	LMRL-1.5	▷	•	•	•	•
1/8"	Male Rotating Lock	LMRL-2	▷	•	•	•	•
5/32"	Male Rotating Lock	LMRL-2.5	▷	•	•	•	•
3/16"	Male Rotating Lock	LMRL-3	▷	•	•	•	•
1/4"	Male Rotating Lock	LMRL-4	▷	•	•	•	•

Use with Snap Lock pictured below



Snap Lock							
Animal Derivative Free				Animal Derivative Free			
Size	Description	Part Number	PP	PPAG	NN	MN	MNAG
Standard	Luer Snap Lock	LSLR	▷	•	•	•	•

Snap Lock - Luer threaded nut snaps onto Stationary Lock Luer and Rotating Lock Luer